 TECHNICAL DATA SHEET

Metallic covers, concealed service top

664-CST-M series, for use on floor boxes

Steel City®



01



02



03

-
- 01 Brass cover
Part no.
664-CST-M-BRS
- 02 Aluminum cover
Part no.
664-CST-M-ALM
- 03 Black cover
Part no.
664-CST-M-BLK

Features:

- Gaskets, installed
- Six inch insulated lanyard attached to frame and cover
- MopTite® Cover (When not in use)

Applications:
For use on different floor types

- Tile
- Carpet
- Wood floors

Materials / Finishes:

- Brass
- Aluminum
- Aluminum, black

Rating:

- 2,000 lb maximum load capacity

Metallic floor box covers are designed for use with 664 series concealed floor boxes.

Certifications / Standards:



Conforms to:

- UL 514 scrub water requirements for tile, carpet and wood floors (MopTite® Cover)

Options:

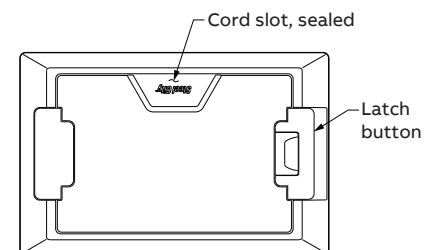
- Lid can be rotated to allow an interchange between open access, for cord exit and sealed unit, for not in use applications.

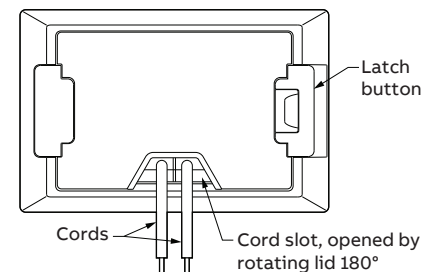
**Closed
Not -in- use:**

**Closed
While -in- use:**

Metallic covers, concealed service top
Drawing

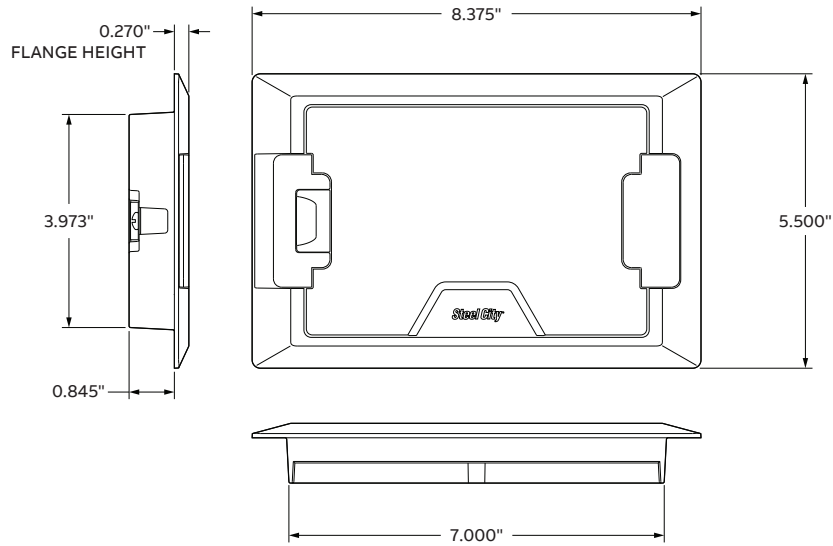

We reserve the right to make technical changes or modify the contents of this document without prior notice. With regard to purchase orders, the agreed particulars shall prevail. ABB does not accept any responsibility whatsoever for potential errors or possible lack of information in this document.

We reserve all rights in this document and in the subject matter and illustrations contained therein. Any reproduction – in whole or in part – is forbidden without prior written consent of ABB.
 Copyright© 2019 ABB. All rights reserved.